

Varenummer: 03446280
Beskrivelse: Fluro Heavy Duty Ledleje GE 280 GW-2RS
Hul Ø280
Note: 280

Mål

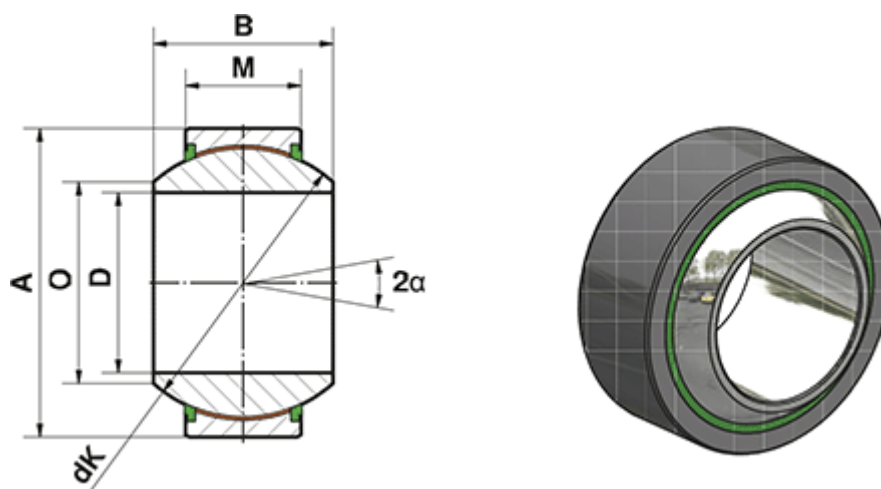

= -	Dynamisk belastning C (kN) = 10800
= -	M = 120
= -	O = 310.6
A = 430	Statisk belastning C0 (kN) = 18000
a (grader) = 15	Vægt (g) = 96500
B = 210	
D = 280	
dK = 375	